



## HF60-0004 SMB-M 5 P MCX

### Contacting SMB-Male

<b>Centers (mm/mil)</b>	6,00 / 236
<b>Current (Circular)</b>	10,0 A
<b>Current (Internal)</b>	3,0 A
<b>Impedance [Z]</b>	50 Ohm
<b>Frequency</b>	5 GHz
<b>Temperature</b>	-20°C...+80°C

#### Spring Force (cN ±20%)

	Preload	Nominal
Total	-	530
Internal Cont.	75	130
Circular Cont.	90	400

#### Travel (mm)

	Nominal	Maximum
Internal Cont.	2,0	3,7
Circular Cont.	4,0	5,0
Wrench Size		3,5 / 4,0

#### Materials and Plating

Internal Cont.	BeCu, gold plated
Circular Cont.	BeCu, gold plated
Barrel	Brass, gold plated
Spring Internal Cont.	Music Wire, gold plated
Spring Circular Cont.	Stainless steel, unplated
Receptacle	Brass, gold plated

#### Accessories

Insertion tool receptacle	FEWZ-822E0
Receptacle Standard	H860
Floating Receptacle	H860FL
Cable 700 mm up to 3 GHz	H860AE1, H860AE3, H860AE4
Cable 700 mm up to 10 GHz	H860AE2

#### Drill Size (mm)

H860	4,99 - 5,00
H860FL	7,99 - 8,01

#### Projection Height (mm)

H860 with HF60-0004	13,25
H860FL with HF60-0004	14,35

#### SMB-Male

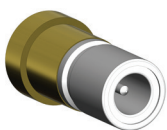

HF86005B0004G530

HF86005B0004G530M

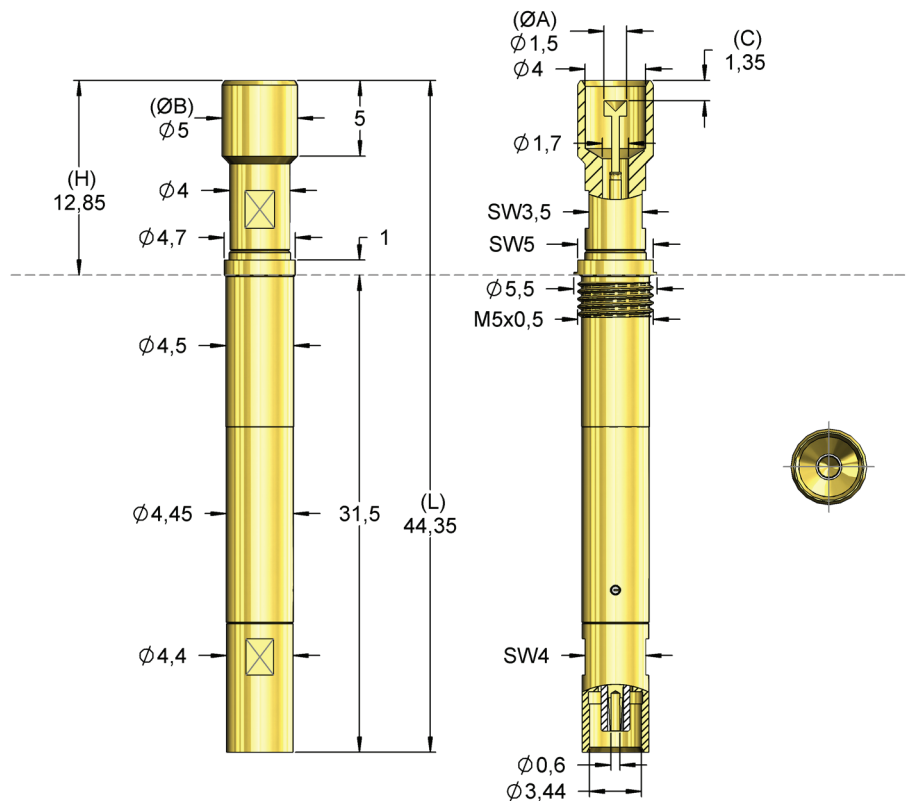

For contacting SMB-Male connectors.

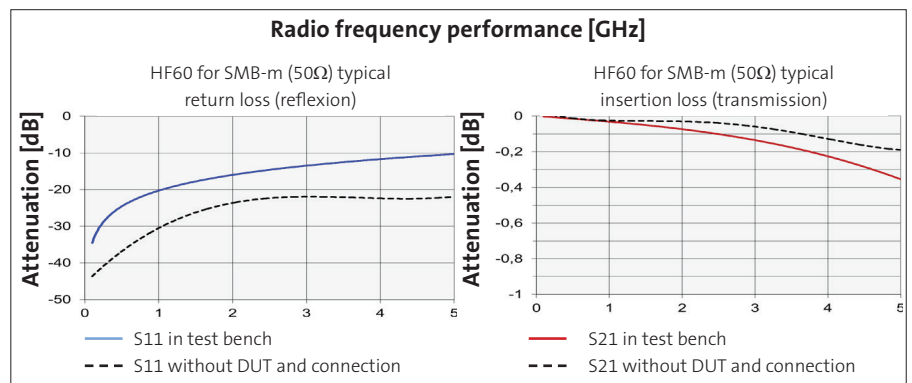
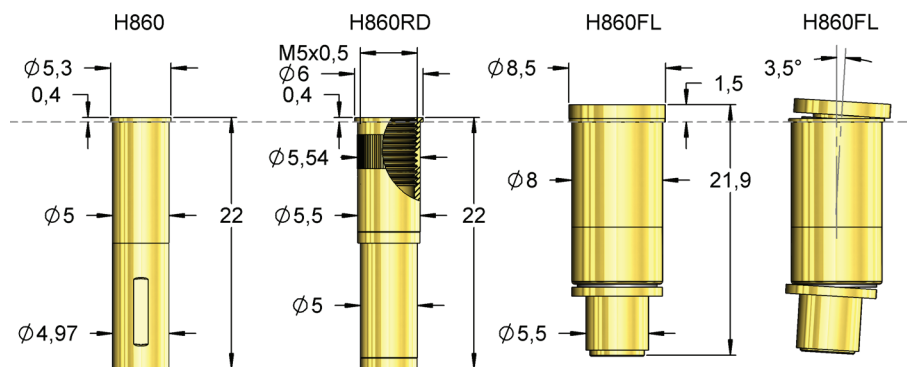

Order Code	Sense Pin	Tip Style	Ø A	Ø B	C	H	L	Version
HF86005B0004G530		05	1,50	5,00	- 1,35	12,85	44,35	-





# CONNECTION CABLES

## for Types HF860/HF66

### Connection Cables for HF860



**Connection element with pre-assembled coaxial cable RG 316.**  
Impedance: 50 Ohm  
Cutoff frequency: recommended up to **3 GHz**  
Standard length: 700 mm

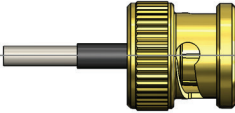

**H86oAE1**  Coax cable 3GHz 700 mm  
MCX-M straight unassembled



**H86oAE3**  Coax cable 3GHz 700 mm   
MCX-M straight SMA-M straight

**H86oAE4**  Coax cable 3GHz 700 mm   
MCX-M straight BNC-M straight

**Connector with pre-assembled coaxial cable Multiflex 86.**  
Impedance: 50 Ohm  
Cutoff frequency: recommended up to **10 GHz**  
Standard length: 700 mm

**H86oAE2**  Coax cable 10GHz 700 mm   
MCX-M straight SMA-M straight

**H86oAE5**  Coax cable 10GHz 1500 mm   
MCX-M straight SMA-M straight

**H86oAE6**  Coax cable 10GHz 800 mm   
MCX-M angled SMA-M gerade

## Tools

### for HF60 and H860

The FEWZ-822E0 is used to insert the receptacles H860/H860FL into the mounting plate.

The internal contact can be exchanged with the FWZ860SW35 and FWZ-860SW40.

