



HF60-0016 BNC-F 4 P MCX

Contacting BNC-Female

NEW

Centers (mm/mil)	8,50 / 335
Current (Circular)	10,0 A
Current (Internal)	3,0 A
Impedance [Z]	50 Ohm
Frequency	6 GHz
Temperature	-20°C...+80°C

Spring Force (cN ±20%)

	Preload	Nominal
Total	-	550
Internal Cont.	75	150
Circular Cont.	90	400

Travel (mm)

	Nominal	Maximum
Internal Cont.	2,0	2,7
Circular Cont.	4,0	4,6
Wrench Size		3,5 / 4,0

Materials and Plating

Internal Cont.	BeCu, gold plated
Circular Cont.	BeCu, gold plated
Barrel	Brass, gold plated
Spring Internal Cont.	Music Wire, gold plated
Spring Circular Cont.	Stainless steel, unplated
Receptacle	Brass, gold plated

Accessories

Insertion tool receptacle	FEWZ-822E0
Receptacle Standard	H860
Floating Receptacle	H860FL
	H860AE1,
Cable 700 mm up to 3 GHz	H860AE3,
	H860AE4
Cable 700 mm up to 10 GHz	H860AE2

Drill Size (mm)

H860	4,99 - 5,00
H860FL	7,99 - 8,01

Projection Height (mm)

H860 with HF60-0016	13,8
H860FL with HF60-0016	14,9

BNC-Female

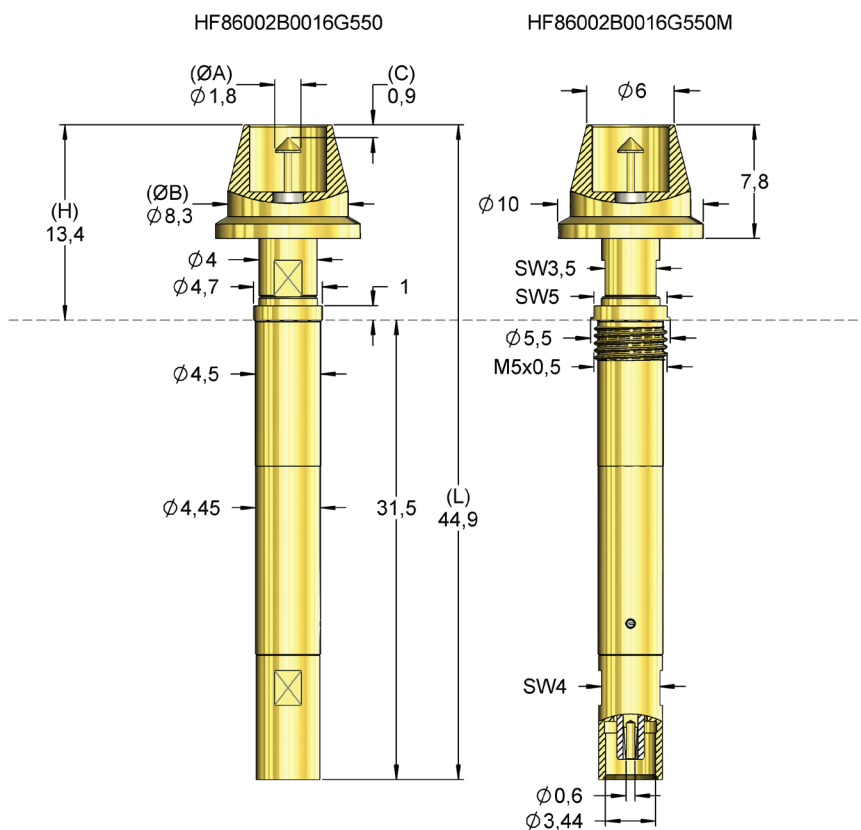
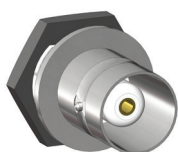

For contacting BNC-Female connectors.

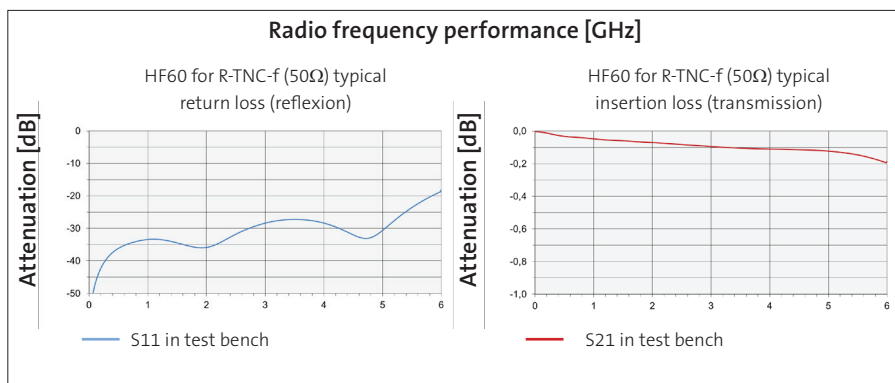
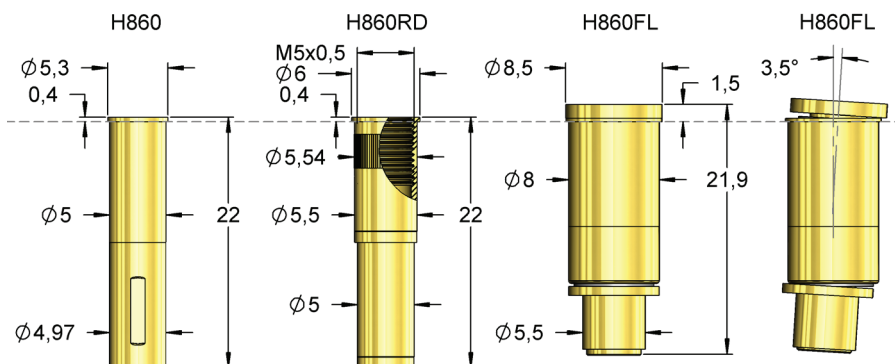

Order Code	Sense Pin	Tip Style	Ø A	Ø B	C	H	L	Version
HF86002B0016G550		02	1,80	8,30	-0,90	13,40	44,90	-





CONNECTION CABLES

for Types HF860/HF66

Connection Cables for HF860



Connection element with pre-assembled coaxial cable RG 316.
Impedance: 50 Ohm
Cutoff frequency: recommended up to **3 GHz**
Standard length: 700 mm

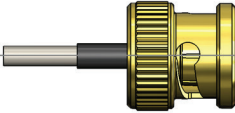

H86oAE1  Coax cable 3GHz 700 mm
MCX-M straight unassembled



H86oAE3  Coax cable 3GHz 700 mm 
MCX-M straight SMA-M straight

H86oAE4  Coax cable 3GHz 700 mm 
MCX-M straight BNC-M straight

Connector with pre-assembled coaxial cable Multiflex 86.
Impedance: 50 Ohm
Cutoff frequency: recommended up to **10 GHz**
Standard length: 700 mm

H86oAE2  Coax cable 10GHz 700 mm 
MCX-M straight SMA-M straight

H86oAE5  Coax cable 10GHz 1500 mm 
MCX-M straight SMA-M straight

H86oAE6  Coax cable 10GHz 800 mm 
MCX-M angled SMA-M gerade

Tools

for HF60 and H860

The FEWZ-822E0 is used to insert the receptacles H860/H860FL into the mounting plate.

The internal contact can be exchanged with the FWZ860SW35 and FWZ-860SW40.

