



**HF60-0014 MMCX-F 6 P MCX**

**Contacting  
MMCX-Female**

**NEW**

<b>Centers (mm/mil)</b>	5,00 / 200
<b>Current (Circular)</b>	10,0 A
<b>Current (Internal)</b>	3,0 A
<b>Impedance [Z]</b>	50 Ohm
<b>Frequency</b>	6 GHz
<b>Temperature</b>	-20°C...+80°C

**Spring Force (cN ±20%)**

	<b>Preload</b>	<b>Nominal</b>
Total	-	530
Internal Cont.	100	130
Circular Cont.	90	400

**Travel (mm)**

	<b>Nominal</b>	<b>Maximum</b>
Internal Cont.	1,0	1,7
Circular Cont.	4,0	5,0
Wrench Size		3,5 / 4,0

**Materials and Plating**

Internal Cont.	BeCu, gold plated
Circular Cont.	BeCu, gold plated
Barrel	Brass, gold plated
Spring Internal Cont.	Music Wire, gold plated
Spring Circular Cont.	Stainless steel, unplated
Receptacle	Brass, gold plated

**Accessories**

Insertion tool receptacle	FEWZ-822E0
Receptacle Standard	H860
Floating Receptacle	H860FL
	H860AE1, H860AE3, H860AE4
Cable 700 mm up to 3 GHz	
Cable 700 mm up to 10 GHz	H860AE2

**Drill Size (mm)**

H860	4,99 - 5,00
H860FL	7,99 - 8,01

**Projection Height (mm)**

H860 with HF60-0014	11,1
H860FL with HF60-0014	12,2

**MMCX-Female**

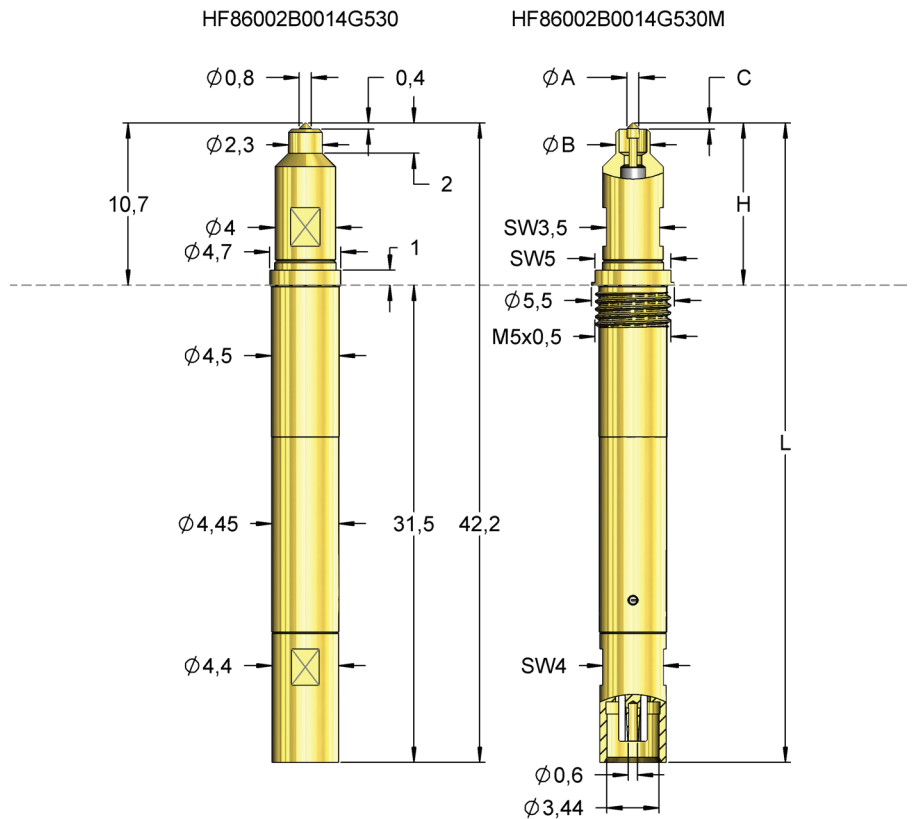
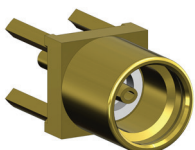

For contacting MMCX-Female connectors.

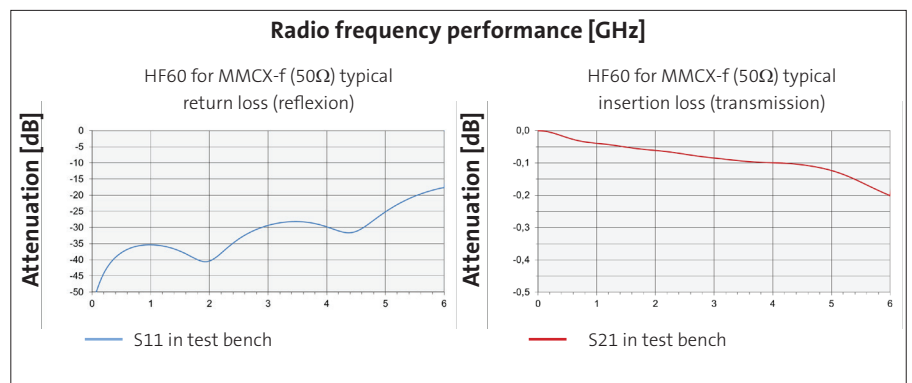
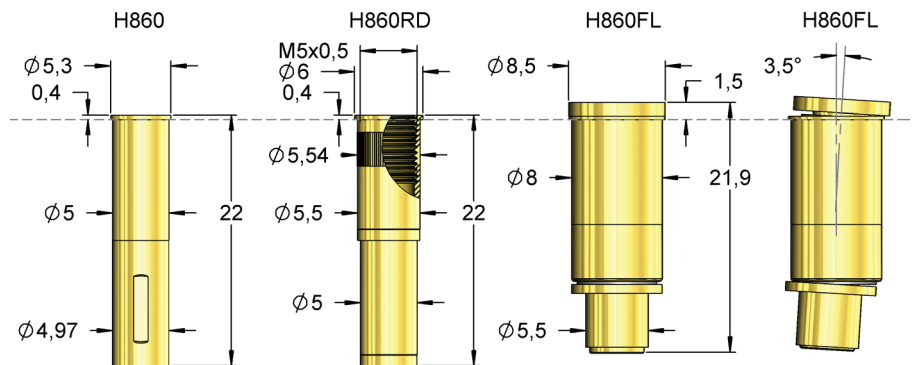

Order Code	Sense Pin	Tip Style	Ø A	Ø B	C	H	L	Version
HF86002B0014G530		02	0,80	2,30	0,40	10,70	42,20	-





# CONNECTION CABLES

## for Types HF860/HF66

### Connection Cables for HF860



**Connection element with pre-assembled coaxial cable RG 316.**  
Impedance: 50 Ohm  
Cutoff frequency: recommended up to **3 GHz**  
Standard length: 700 mm

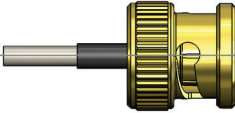

**H86oAE1**  Coax cable 3GHz 700 mm  
MCX-M straight unassembled



**H86oAE3**  Coax cable 3GHz 700 mm   
MCX-M straight SMA-M straight

**H86oAE4**  Coax cable 3GHz 700 mm   
MCX-M straight BNC-M straight

**Connector with pre-assembled coaxial cable Multiflex 86.**  
Impedance: 50 Ohm  
Cutoff frequency: recommended up to **10 GHz**  
Standard length: 700 mm

**H86oAE2**  Coax cable 10GHz 700 mm   
MCX-M straight SMA-M straight

**H86oAE5**  Coax cable 10GHz 1500 mm   
MCX-M straight SMA-M straight

**H86oAE6**  Coax cable 10GHz 800 mm   
MCX-M angled SMA-M gerade

## Tools

### for HF60 and H860

The FEWZ-822E0 is used to insert the receptacles H860/H860FL into the mounting plate.

The internal contact can be exchanged with the FWZ860SW35 and FWZ-860SW40.

